

Quick start guide MD4A-2220-EU

Mini magnetic monitor



Magnetic Activation

Any questions? Call us on 01246 450789

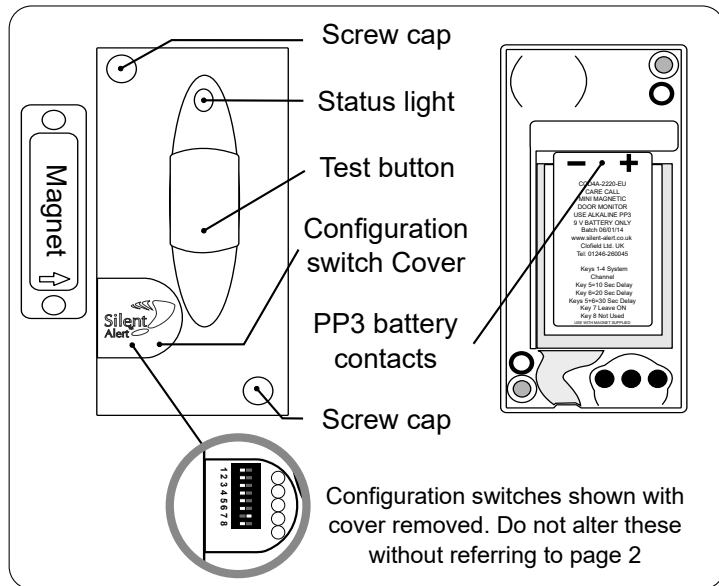

1. Install a 9 volt PP3 alkaline or lithium battery making sure to observe the correct polarity.

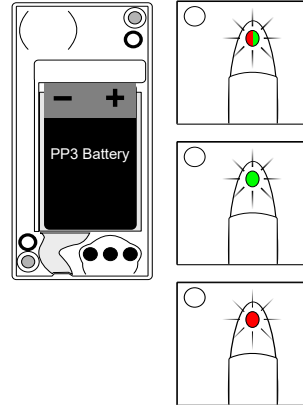

When a battery is first fitted the indicator light will flash red then green a few times .

The light will then will flash green several times to show the battery voltage.
9 flashes = 9Volts in the battery.

If the light flashes red at this point the battery is flat and will need to be replaced.

To repeat the battery check remove the battery, press the test button then re-insert the battery to start the sequence again.

2. The monitor is activated using an internal reed switch and a magnet.

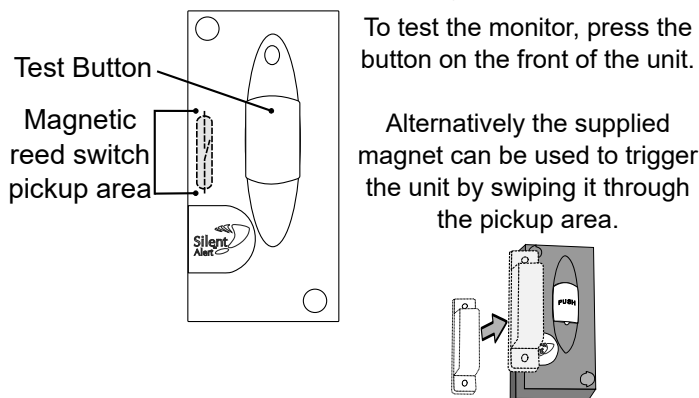

NOTE* The magnet must pass within 1cm of the pickup area to activate the unit.

- 3.

Secure the Mini Monitor to the door frame as close as possible to the edge of the door using the screws provided. The Magnet must pass within 1cm of the pickup area to trigger the unit.

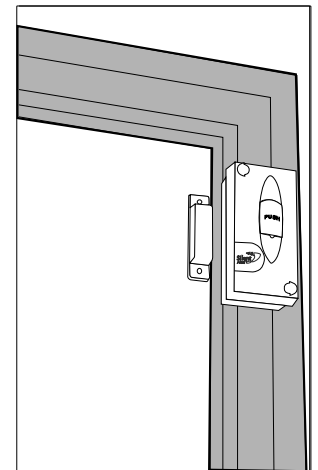
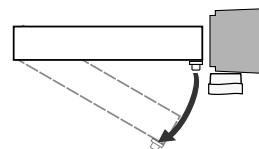

- 4.

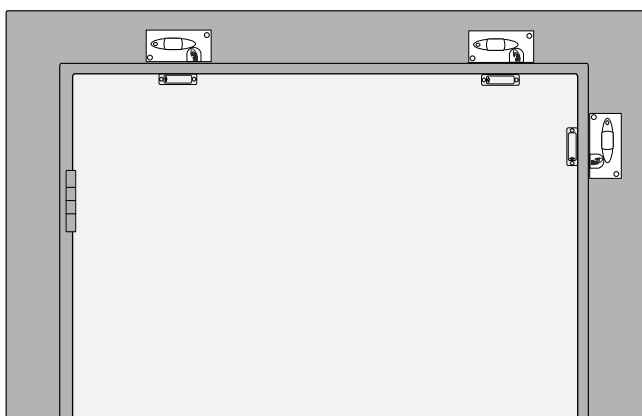

We recommend mounting the monitor opposite to the door hinge. The magnet does not need to be in close proximity to the pickup area when the door is closed as the unit is triggered when the magnet passes through the pickup area.

The magnet needs to pass within 1cm of the pickup area as the door is opened. It is possible to mount the monitor in a variety of positions as shown in the diagram. Experiment to find the best position before fixing to the door frame. Once the optimum position has been established the magnet should be secured to the door frame using the sticky pad or screws provided.

Deactivating & reactivating the door monitor

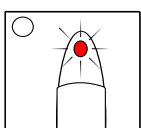

Press and hold the test button until the light flashes red, then release. This will deactivate the door sensor.

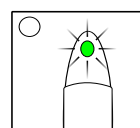

Press and hold the test button until the light flashes green, then release. This will reactivate the door sensor.

WARNING! Your device and its accessories are not toys. They may contain small parts. Keep them out of the reach of small children.

Advanced settings MD4A-2220-EU

Mini magnetic monitor



Any questions? Call us on 01246 450789

It is possible for the monitor to light up different keys on the Pager or SignWave. This allows more than one mini monitor to be used on a SA3000 system.

Move the relevant key to the right .

Press the test button and check the correct event is received by the Pager or SignWave

The diagram illustrates the process of selecting a key on the monitor. It shows four stages: 1. A key is highlighted. 2. A red arrow points to the right, indicating the key is moved. 3. A second red arrow points to the right, indicating the key is moved again. 4. A third red arrow points to the right, indicating the key is moved a third time. Each stage shows a vertical column of eight keys labeled 1 through 8.

Changing the trigger delay

It is possible to set trigger delays allowing a set amount of time to pass for the user to clear the door before the monitor will transmit.

- To change the delay you need to reset the monitor:
Remove the battery, press the push button, replace the battery.
- After the flashing red/green startup sequence the light will shine constant green.
- Press and release the button whilst the light is green. The light will flash red once, twice then three times .
- To set the delay, briefly press the test button at the desired number of flashes.
- 1 flash = 10 seconds
2 flashes = 15 seconds
3 flashes = 30 seconds
The indicator light will light green to confirm the selection.
- The monitor will then perform the battery voltage level display and start as normal. Press the test button to confirm the correct zone has been selected.

Changing the system channel code

NOTE. In most cases it is not necessary to change the system code. However, when one or more systems are in close proximity, system codes can be used to avoid interference from other SA3000 systems using up to a maximum of 16 channels.

The monitor is supplied with no system code switches set (system code 1). For reference this is the factory setting should you need to re-set the unit.

System codes can be set using key switches 1 - 4.

The diagram to the right shows the 16 possible combinations.

Be sure that the same system code is set on the receiver to be used and any other monitoring options in that system.

The diagram shows 16 possible system code combinations, numbered 1 through 16. Each combination is represented by a vertical column of eight keys labeled 1 through 8. The keys are either lit or unlit to represent the system code. For example, code 1 has key 1 lit, while code 16 has all keys lit.