

# Quick start guide MM4A-NEAT-DDA

## Connecting Silent Alert to the Possum neat LINK



Any questions? Call us on 01246 450789

### Connecting to Possum Neat LINK

Please refer to the NEAT LINK installation instructions before connecting our unit to the system.

The Telecare technician should refer to pages 7 & 9 of the installation and programming guide regarding connecting an alarm transmitter to the LINK.

**1.**

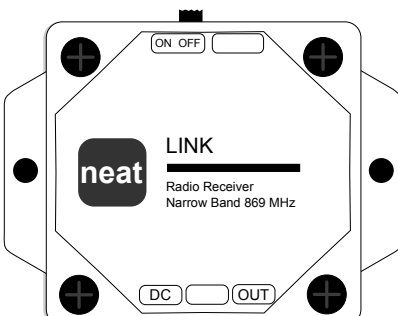

To trigger the Silent Alert system the NEAT link will need to be configured to output a 3 second short when a smoke alarm is triggered.

To configure the unit the lid must be removed by removing the 4 mounting screws.

**2.**

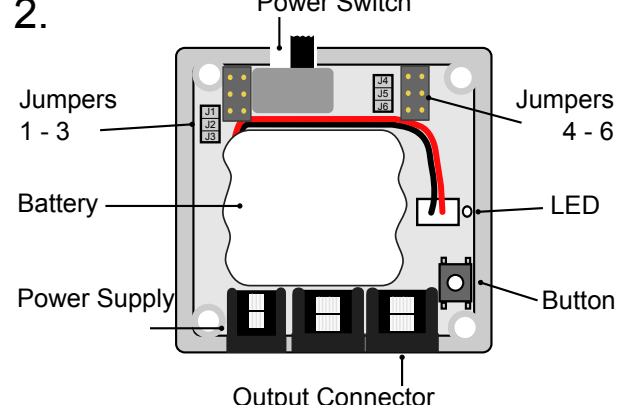

Power Switch

Jumpers 1 - 3

Battery

Power Supply

Output Connector

Jumpers 4 - 6

LED

Button

**3.**

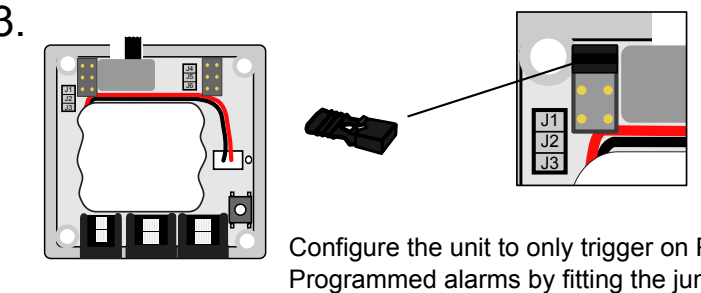

Configure the unit to only trigger on Pre Programmed alarms by fitting the jumper to position one.

**4.**

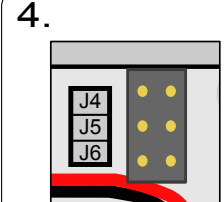

Ensure no jumpers are set on positions 4, 5 or 6. This will set the unit to pulse mode whereby the output relay will be closed for 3 seconds when an alarm is received.

**5.**

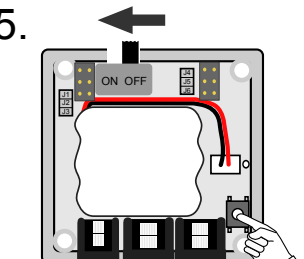

Ensure the Link is switched off. Press and hold the button inside of the LINK while switching LINK on.

**6.**

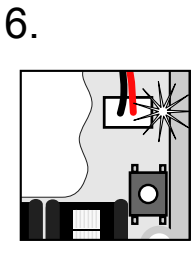

Keep holding the button and wait until the LED inside LINK flashes once to configure the smoke alarm to channel one of the link. Release the button. This will put the link into programming mode.

**7.**

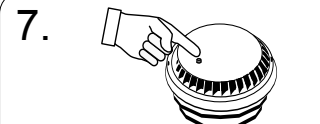

Activate the NEAT Smoke alarm transmitter. The LED inside the LINK will flash once to indicate the alarm code is stored.

**8.**

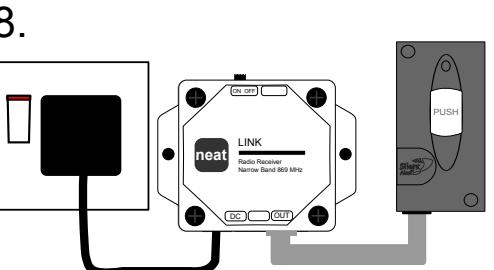

Connect the LINK's power supply and connect the Silent Alert monitor to the LINKS output. When the POSSUM smoke alarm activates the Silent Alert Pager or SignWave will alert the deaf user.

**9.**

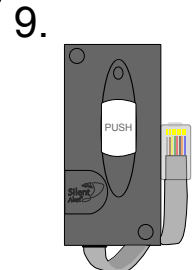

For information on configuring the Silent Alert monitor please refer to the advance settings overleaf.

### WARNING

Do not connect the equipment in any way other than illustrated.

Clofield Ltd accepts no responsibility for damage caused by incorrect installation.

**WARNING! Your device and its accessories are not toys. They may contain small parts. Keep them out of the reach of small children.**

# Quick start guide MM4A-NEAT-DDA

## Mini Monitor for use with NEAT LINK



Any questions? Call us on 01246 450789

This quick start guide explains the process of connecting Silent Alert equipment to certain Telecare communicators for DDA compliance.

Whilst a wireless smoke alarm unit will alert the call centre, a deaf or hard of hearing person may miss the alarm and be unaware of the danger. By using a Silent Alert DDA kit, the user will be alerted immediately and can respond or react as necessary. This ensures deaf and hard of hearing people can be made aware of integrated Telecare smoke alarms whilst reducing false alarm call outs.

The user will also be able to expand on the benefits of the Telecare system by having access to doorbell, telephone, baby alarm and door entry systems whilst still having the security of a remotely monitored smoke alarm and emergency pendant.

**This information is not intended to replace the manufacturers user instructions. The assistance of the Telecare providers technicians will be required to enable correct output.**

### Standard operation

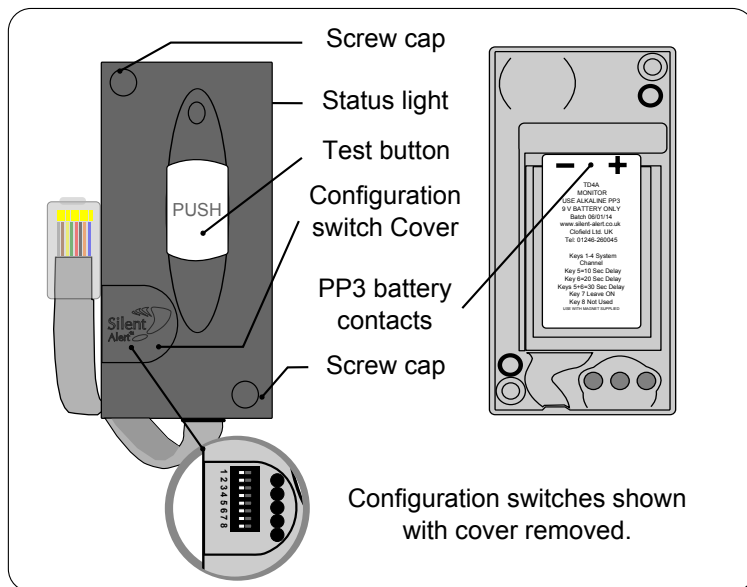

1. Install a 9 volt PP3 alkaline or lithium battery making sure to observe the correct polarity.

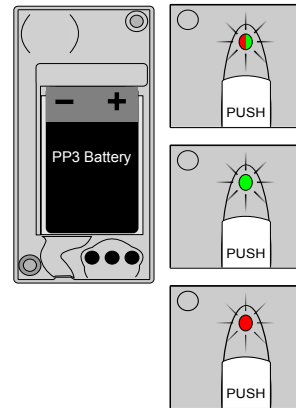

When a battery is first fitted the indicator light will flash red then green a few times.

The light will then flash green several times to show the battery voltage.  
9 flashes = 9Volts in the battery.

If the light flashes red at this point the battery is flat and will need to be replaced.

To repeat the battery check remove the battery, press the test button then re-insert the battery to start the sequence again.

2. Move control keys 5, 6 & 7 to the right.

3. The monitor will now trigger when the telecare unit activates its external output.  
A fire signal will be sent to the Pager or SignWave when the Telecare relay activates.

4. Enabling deaf or hard of hearing people to respond to Telecare smoke alarms.

It is possible for the monitor to light up different keys on the Pager or SignWave.

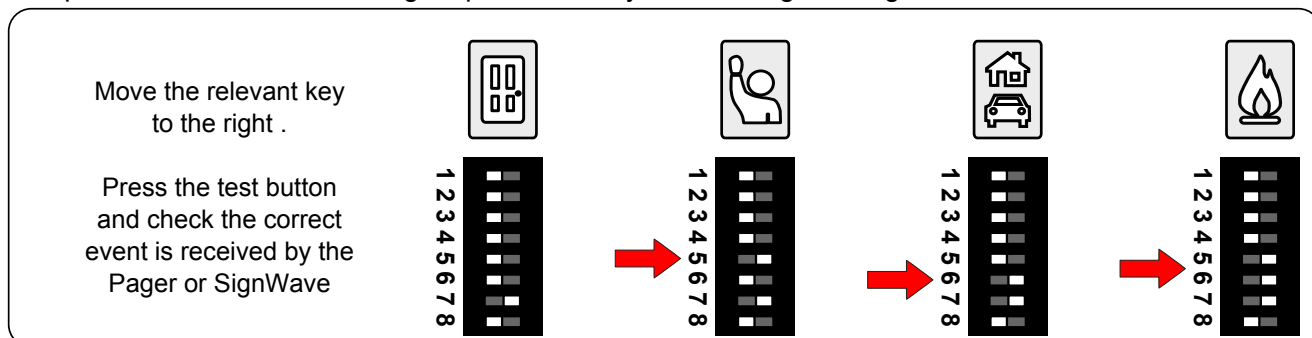

For more information on configuring the Mini Monitor please refer to the dedicated quick guide supplied with each unit. Alternatively, you can download the information from our website at [www.silent-alert.co.uk](http://www.silent-alert.co.uk)

**WARNING! Your device and its accessories are not toys. They may contain small parts. Keep them out of the reach of small children.**